

TUBE FIRED FRYERS 25 LB. FLOOR MODEL

IMPERIAL®

Model Number
IFS-25

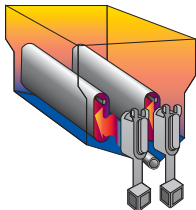

Tube fired burners have a large heat transfer area.

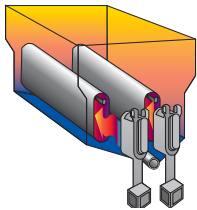

Large cool zone captures and hold particles out of the fry zone.

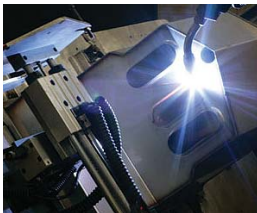

Robotic welding is precise, virtually eliminating leaks.



IFS-25 shown

TUBE FIRED BURNERS - High efficiency cast iron burners have a large heat transfer area.

- Tubes are constructed of heavy gauge metal with a built-in deflector system.
- 70,000 BTU (21 KW) total output.
- Millivolt temperature control circuit.
- Snap acting thermostat has a 200° F - 400° F (93° C-204° C) temperature range.
- Fast recovery to desired temperature.
- Heats oil quickly producing a better tasting product with less oil absorption.
- 100% safety shut-off.

LARGE COOL ZONE - Captures and holds particles below the tubes, out of the fry zone.

- Reduces taste transfer.

STAINLESS STEEL FRYPOTS - Frying area for the 25 lb. model is 6-3/4" x 14" (171 x 356 mm).

- Frypot tubes and sides are robotically welded stainless steel to virtually eliminate leaks.
- Fine mesh wire crumb is included.
- Recessed bottom facilitates draining, slants toward the drain.
- 1-1/4" (32 mm) full port drain valve empties frypot quickly and safely.
- One nickel-plated fry basket with vinyl coated, heat protected handle is included.
- Basket hanger is stainless steel.

EXTERIOR FEATURES - Stainless steel front, door, sides, basket hanger and frypot.

- Welded and polished stainless steel seams.
- Full heat shield protects control panel.
- Full bottom chassis provide structural support.
- Plate mounted 6" (152 mm) heavy duty stainless steel legs.
- One year parts and labor warranty. Limited warranty on frypot, stainless steel frypot is five years pro-rated.



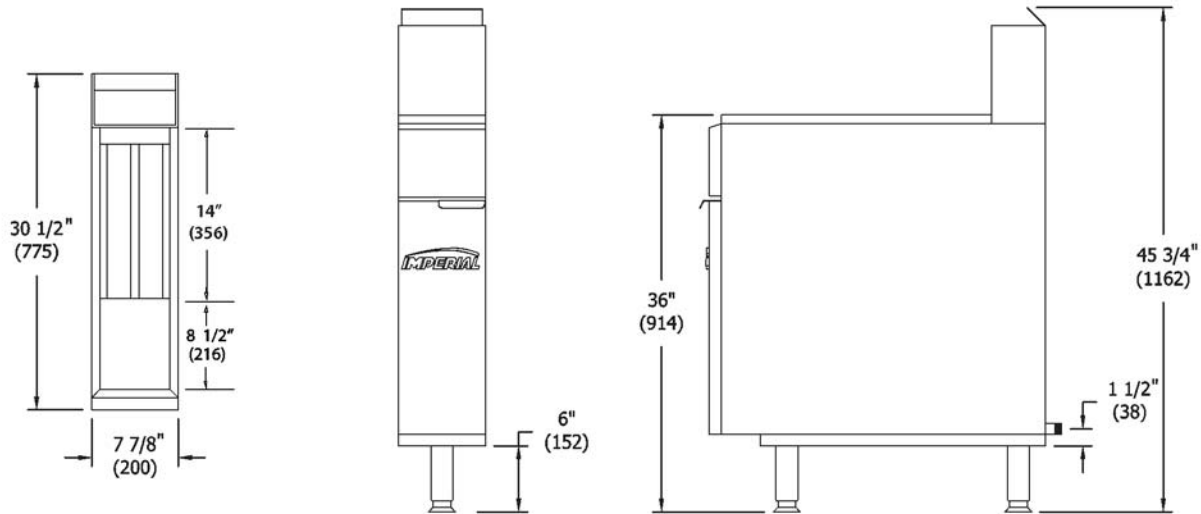

MODEL	OIL CAPACITY	GAS OUTPUT		NUMBER OF BURNERS	SHIP WEIGHT	
		BTU	(KW)		(KG)	LBS
IFS-25	25 lb. (14 L)	70,000	(21)	2	(53)	117
IFS-DS	N/A, drain station	N/A	N/A	N/A	(60)	130

Measurements in () are metric equivalents.

NOTES

- "DS" drain station with storage cabinet, no filter. Includes a 4" (102 mm) deep stainless steel drain pan

MODEL	FRYING AREA	DIMENSIONS	CRATED DIMENSIONS
IFS-25	6-3/4" x 14" (171 x 356 mm)	7-7/8" w x 30-1/2" d x 45-3/4" h (200 x 775 x 1162 mm)	11" w x 31" d x 35" h (279 x 787 x 889 mm)
IFS-DS	N/A	15-1/2" w x 30-1/2" d d x 44-1/4" h (394 x 775 x 1124 mm)	18" w x 31" d x 35" h (457 x 787 x 889 mm)

MANIFOLD PRESSURE		MANIFOLD SIZE
NATURAL GAS	PROPANE GAS	
4.0" W.C.	11.0" W.C.	3/4"

Specify elevation, if over 2,000 ft.

CLEARANCE REQUIREMENTS

For use only on non-combustible floors. Legs or casters are required for non-combustible floors; or 2" (51 mm) overhang is required when curb mounted. Provide 0" clearance from non-combustible surfaces and 6" (152 mm) from combustible surfaces.

OPTIONS AND ACCESSORIES

- Fryer drain station with storage cabinet
- Stainless steel joiner strip
- Manual timer
- Extra fry baskets with vinyl coated handles
- Gas shut off valve, 3/4" N.P.T.
- Quick disconnect and flexible gas hose, 3/4" N.P.T.
- 6" (152 mm) casters

